

teknion

routes



ro

ut

es

Teknion's Routes™ collection, designed in partnership with PearsonLloyd, is a stylish and simple “toolbox” of intuitive furnishings that are as playful as they are practical. Comprising desks, tables, chairs, screens and accessories—all with their own individual character—Routes is designed to allow teams to create flexible, utility-driven and engaging workspaces quickly and efficiently, breaking with convention and introducing a sense of play into the world of work.





Community spaces have gained importance in the modern work environment. The Routes Double Desk provides a touchdown work point that can transform into a workstation for the day. Add in a divider screen between users to create individual workspaces or a mobile knit screen for ultimate user choice.

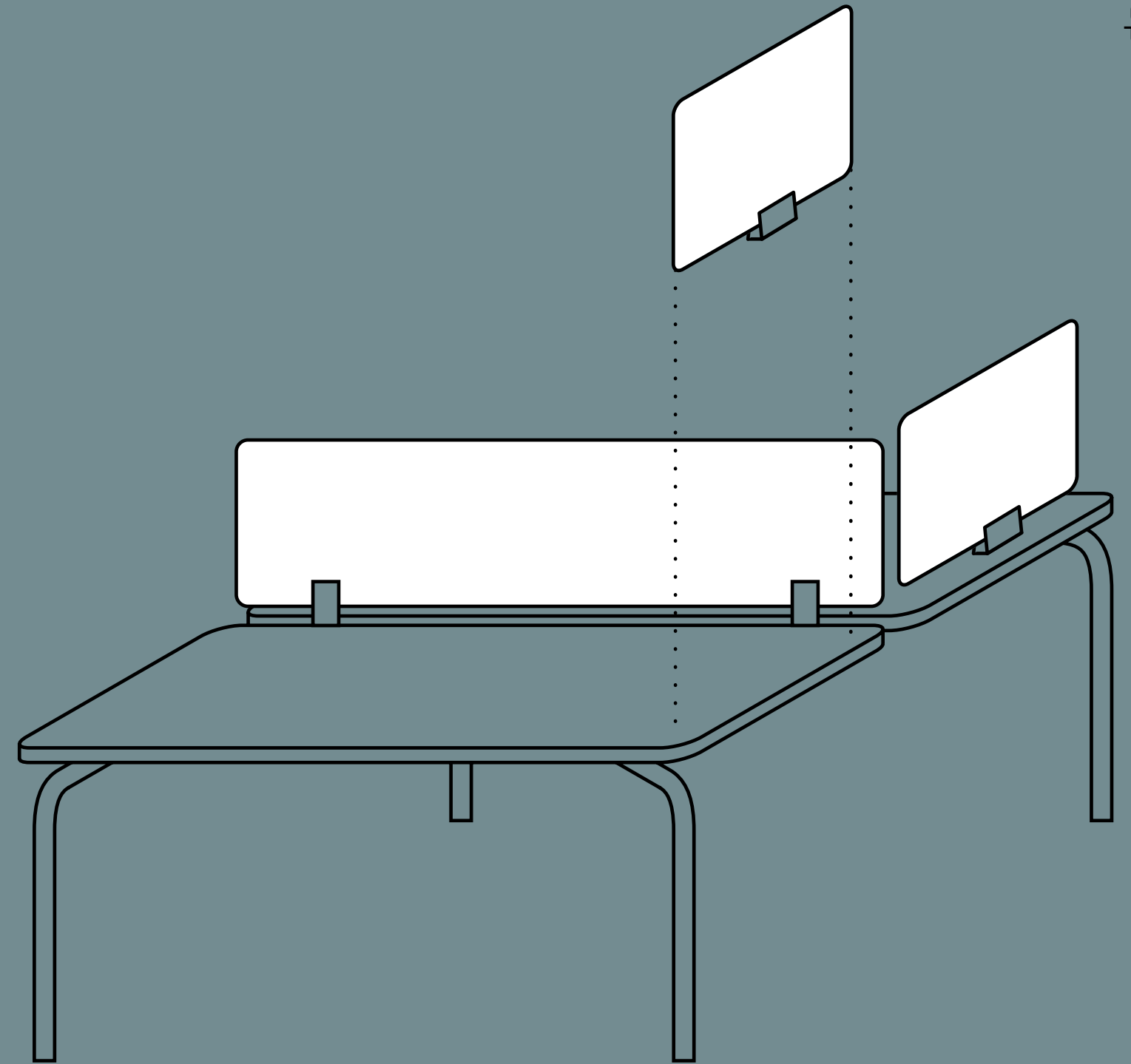

per

fo

nm

an

ce

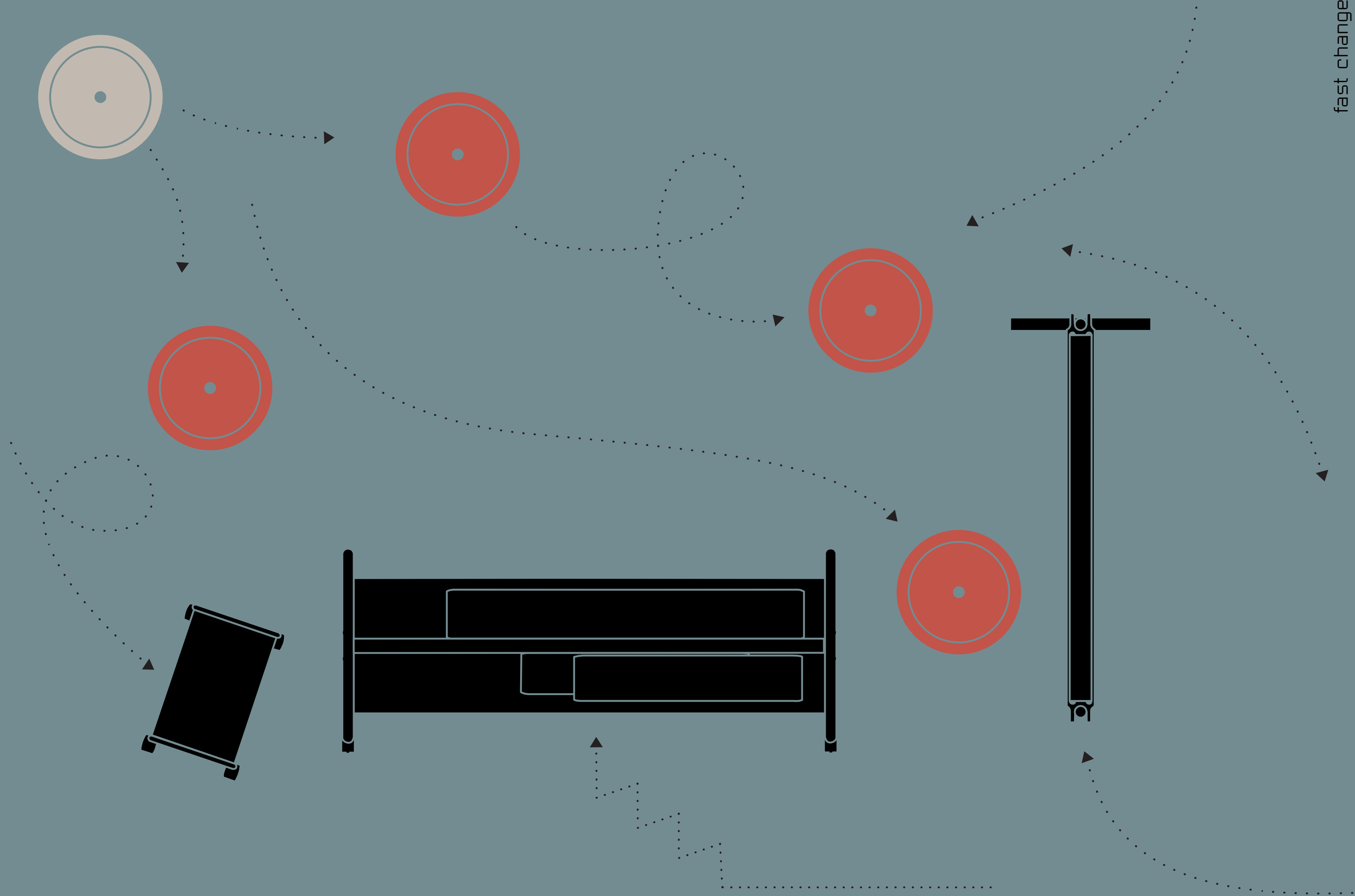

Routes' focus on function is tempered with playfulness and irreverence. A distinct sense of lightheartedness is featured in each piece, with a strong and charismatic personality rooted in the defining curves of bent tubular steel and accent colors of Blue Sage and Signal Red.

This levity is integral to the furniture's purpose—a touch of playfulness and fun can be an important part of effective working practice, and a powerful trigger for creativity. The whimsical nature of Routes makes it appealing to engage with, giving the collection a domestic quality that elevates it above typical office furniture.

"Both work and play fire the imagination and are truly creative forms of activity. 'Workplay' acknowledges the meeting point between both." Tom Lloyd

Routes can be used to build up a complete workspace for a small, tight-knit studio or create casual "pop-up" work hubs across the expanse of a corporate headquarters. Routes offers the ability to swiftly make, unmake and adapt workspaces in response to the changing requirements of individuals, teams and tasks.

The collection creates an opportunity for users to define their ideal "route" to completion of any given task. This ability to facilitate kinetic work is reflected in the collection name: "Routes" denotes intentional mobility—a workplace where people are free to use the furniture as tools to pursue multiple pathways to achieving shared and individual goals.

"Visually, Routes is bold enough so that as you pepper a landscape with various pieces, you recognize that it's a bit different." Luke Pearson



An easel that is writeable, tackable and stackable. Use this mobile board as a writing surface, collaborative space or a space divider. The Routes Work Board allows you to choose your own experience, adapting to multiple ways of working that promotes user choice.

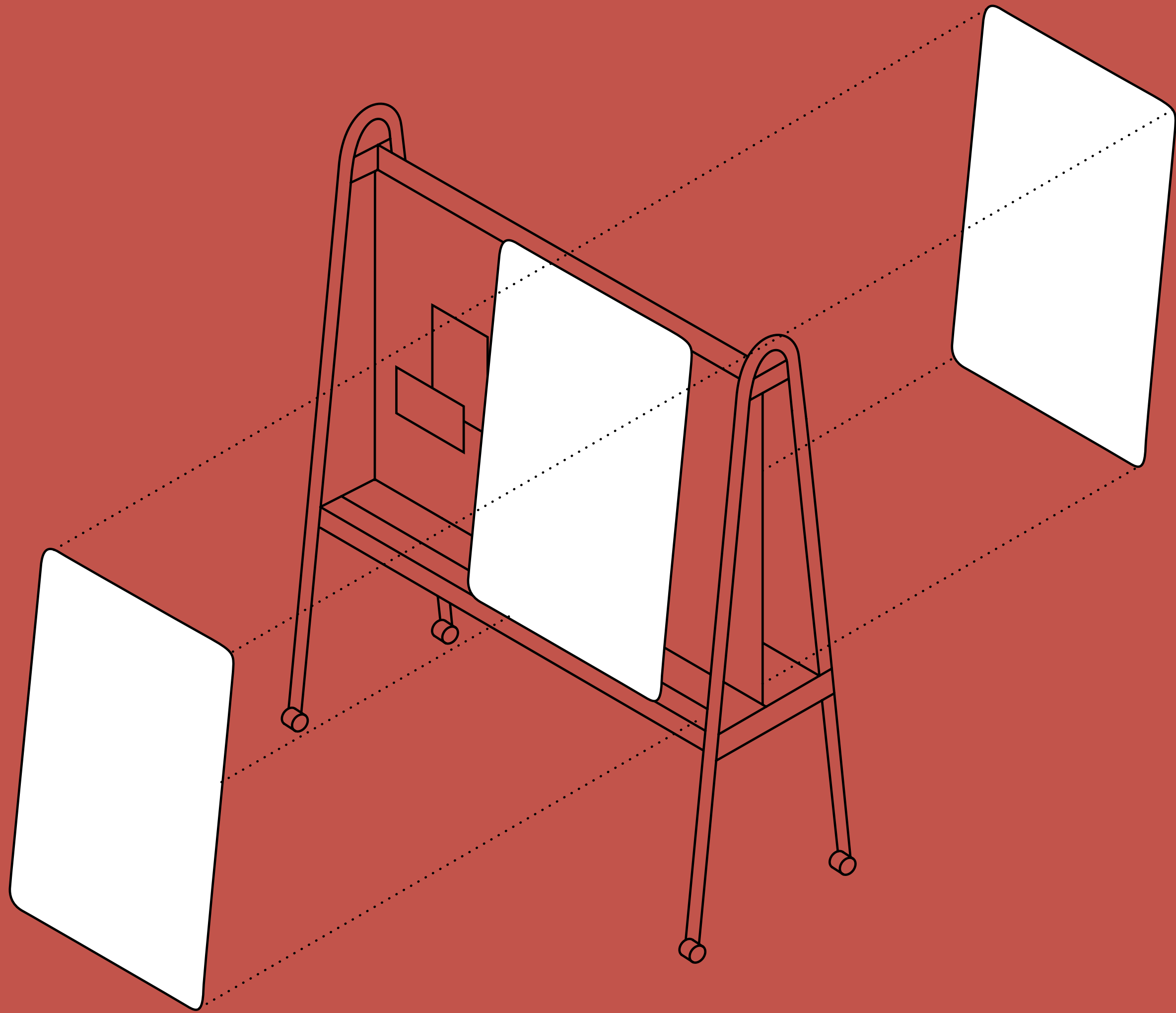



Routes is a simple concept. Pick a way to sit, a place to engage and a space to work. Personal preference is the essence of the new workplace. Routes can be consistently changed to create spaces that are specific to that day's tasks.

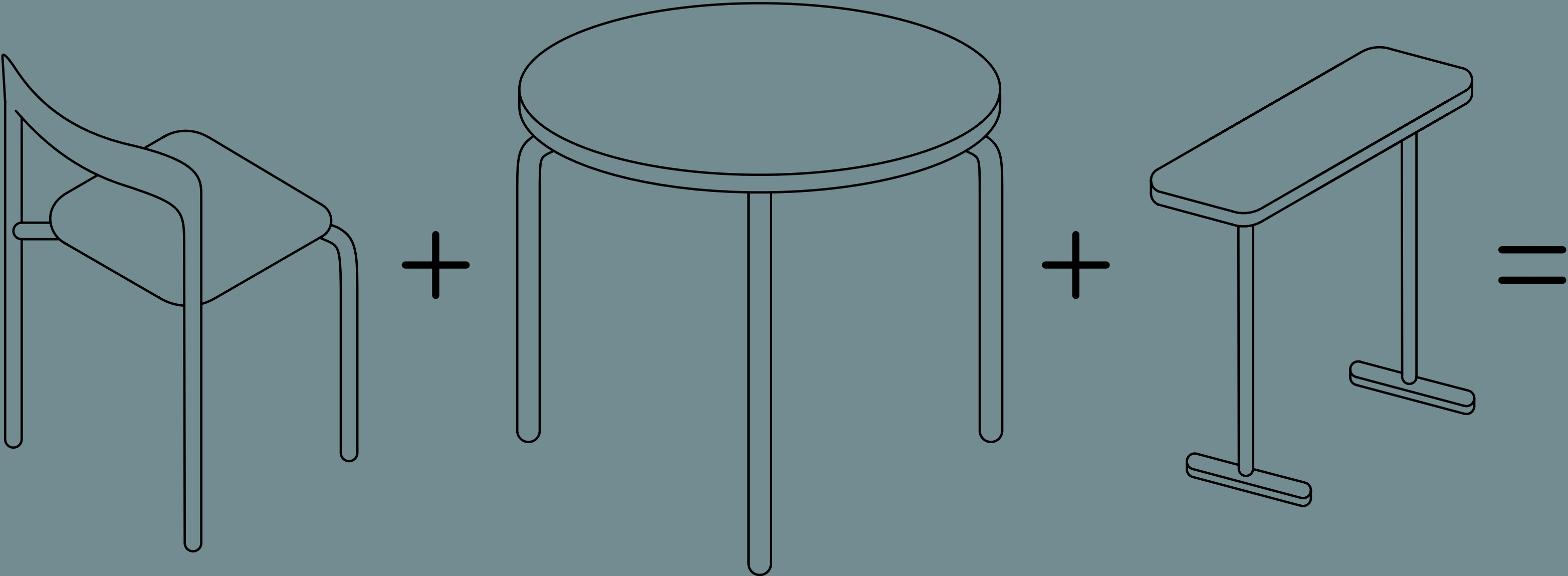





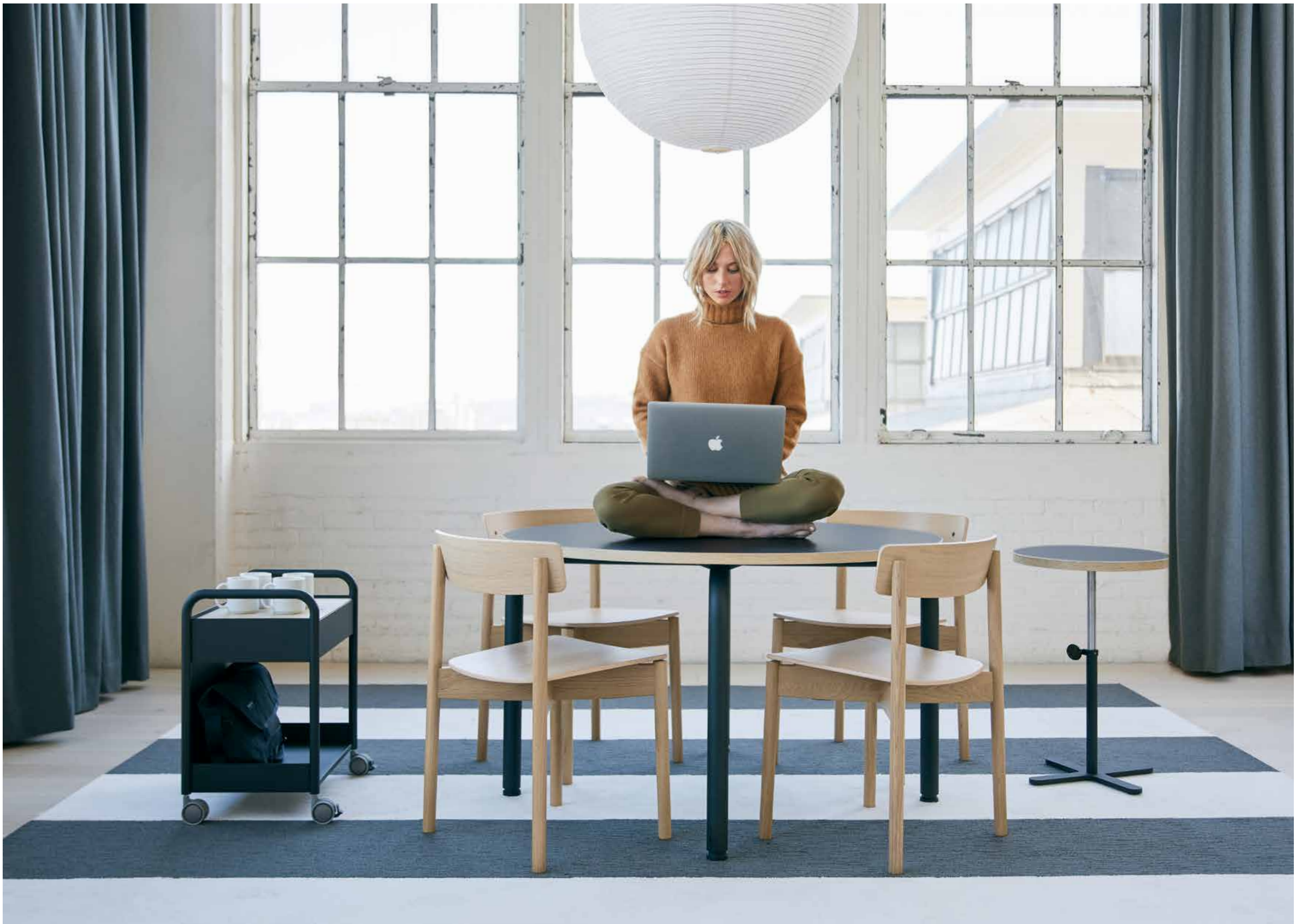



int

uit

ive

Every item in the Routes collection is designed to be as simple and practical as possible to ensure the user intuitively understands how to use it. Routes was conceived and guided by the notion “how simple can something be while still fulfilling its intended function?” By fastidiously applying this economy of means to all collection pieces, Routes delivers a graphic and bold design language driven by a refined utility, without compromising on comfort.

“Simplicity is inherent in the product. You know intuitively how to use it.” Luke Pearson

“You don’t need an instruction manual. Just grab what you need and enjoy using it.” Tom Lloyd



Add this unique fabric screen to any work environment and have complete user choice. From color, height and mobility, the Routes Mobile Soft Screen adds a whole level of user-controlled privacy. Simply adjust the magnetic dowel and change the personality of the space.

mobile soft screen

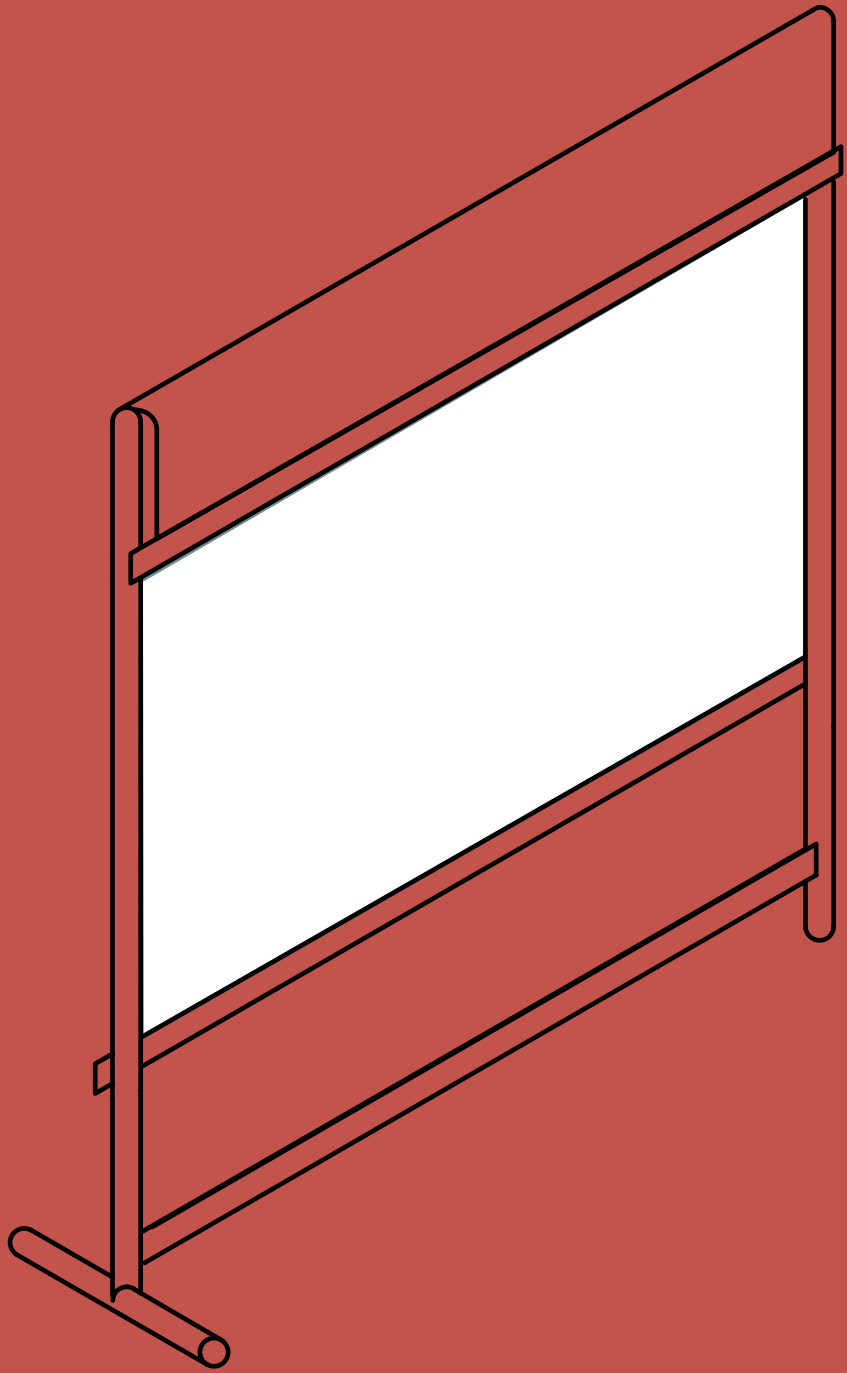
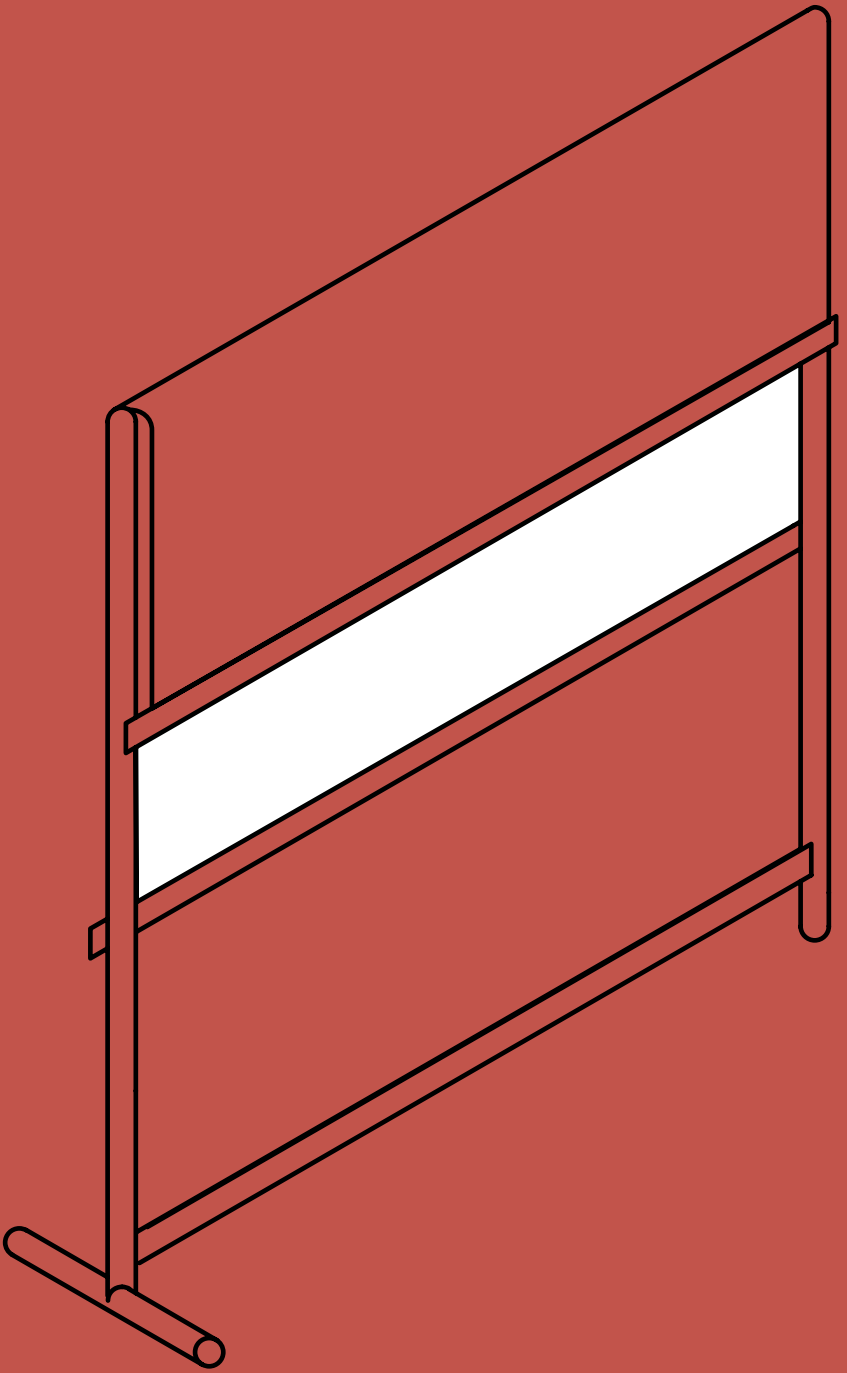
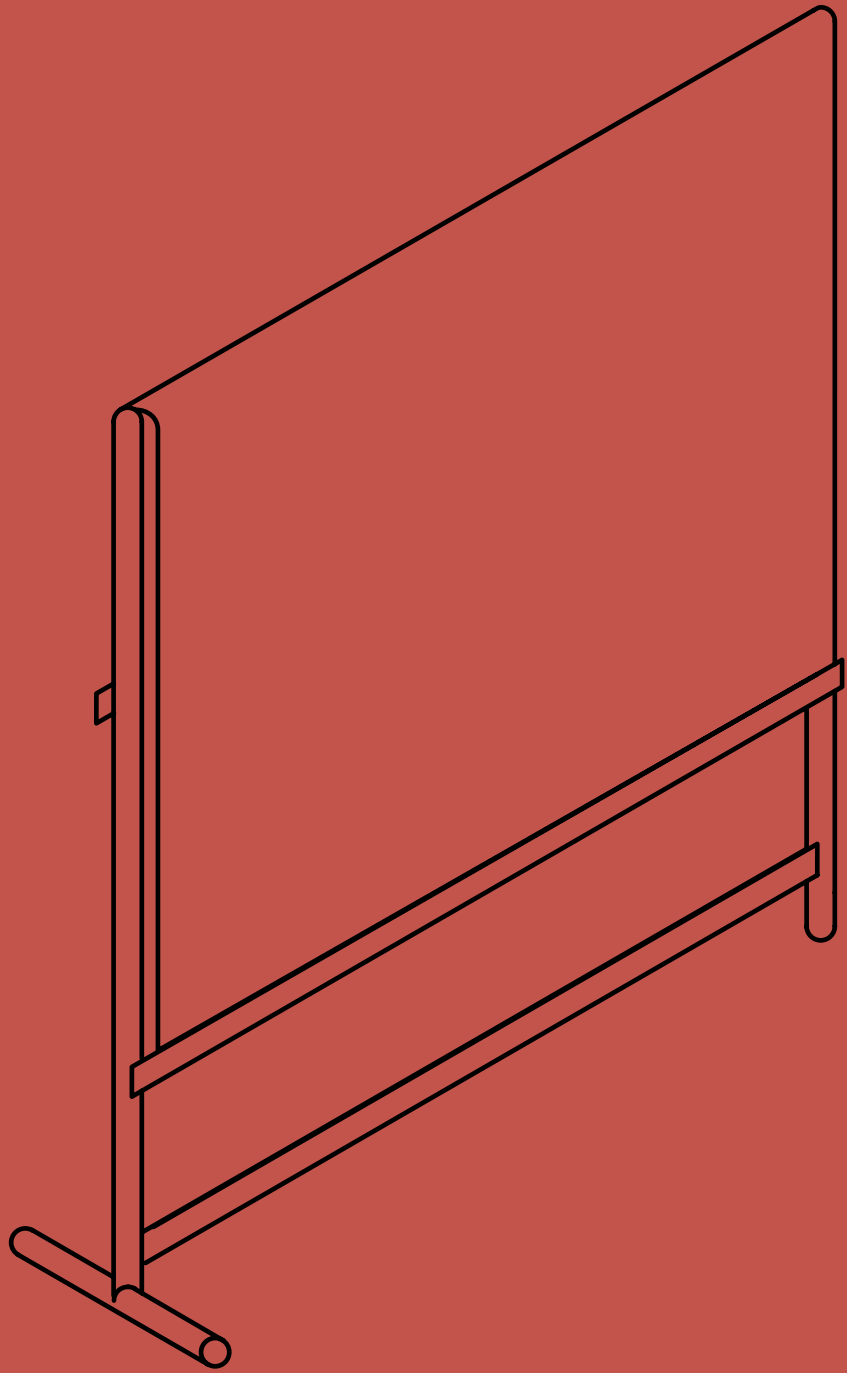

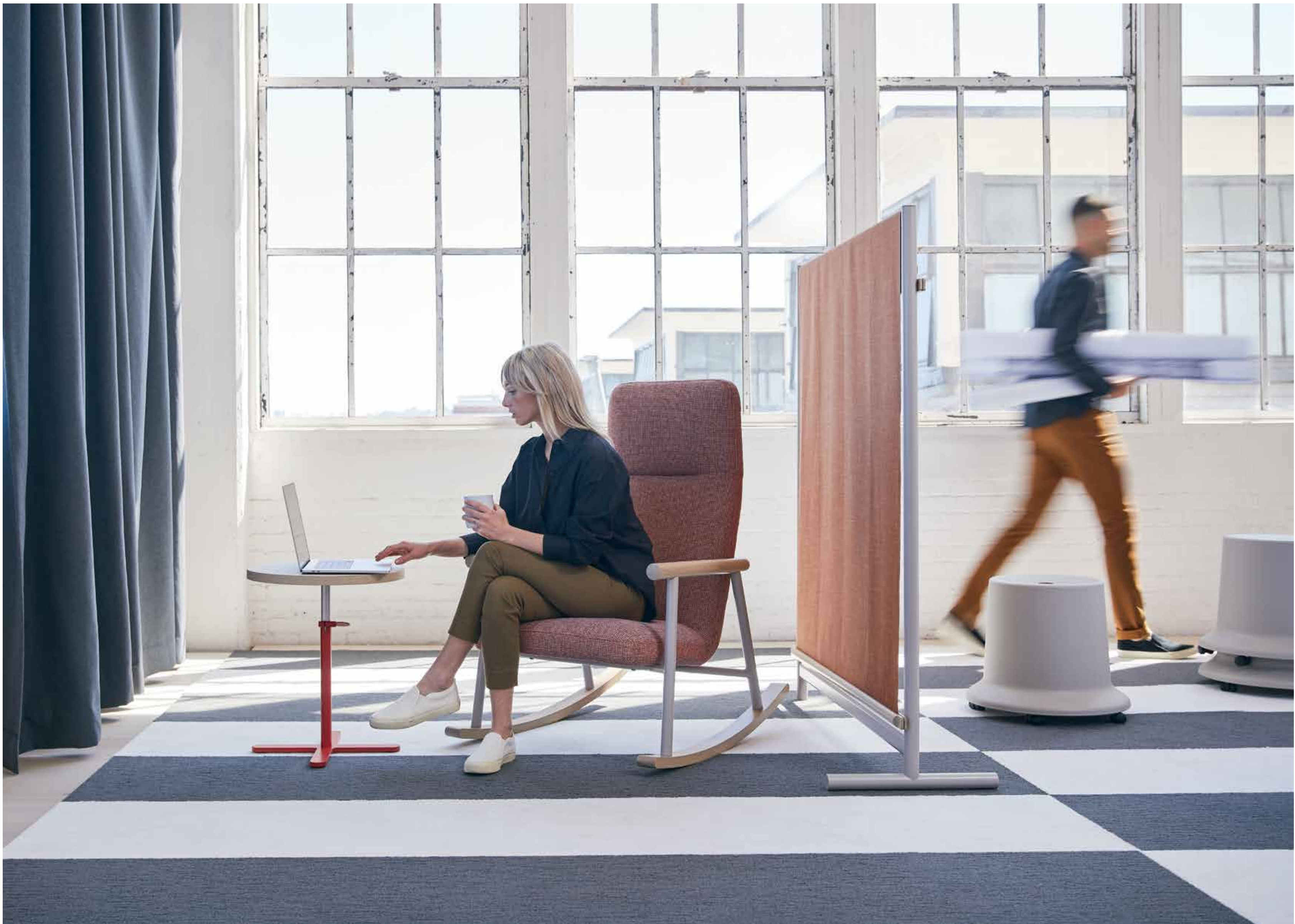

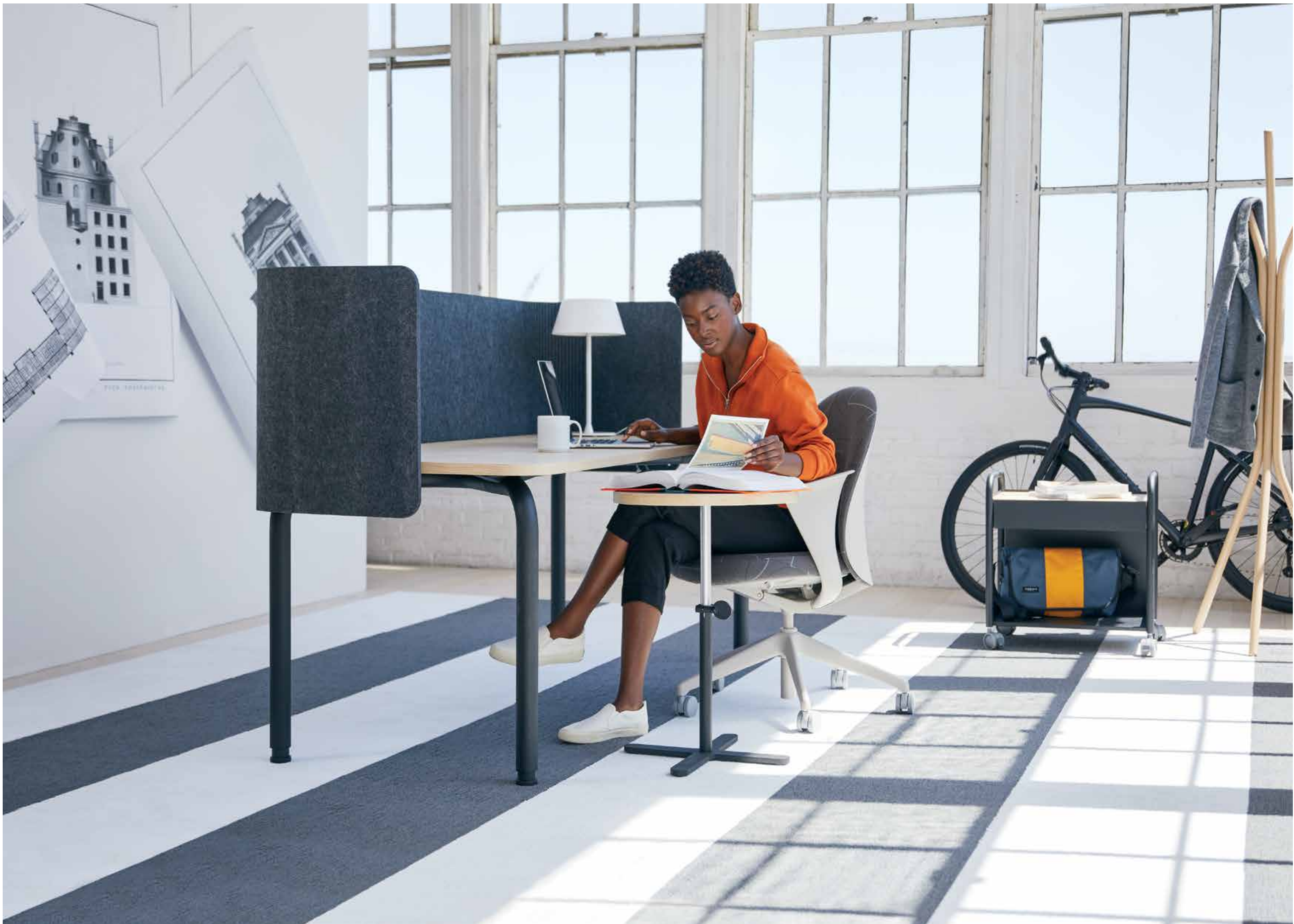



Pick a place to work—pick a level of privacy. Pick the amount of privacy for the task at hand with screens for the front and sides. The soft material of felt brings in a feeling of home to round out a more residential feel in the office.

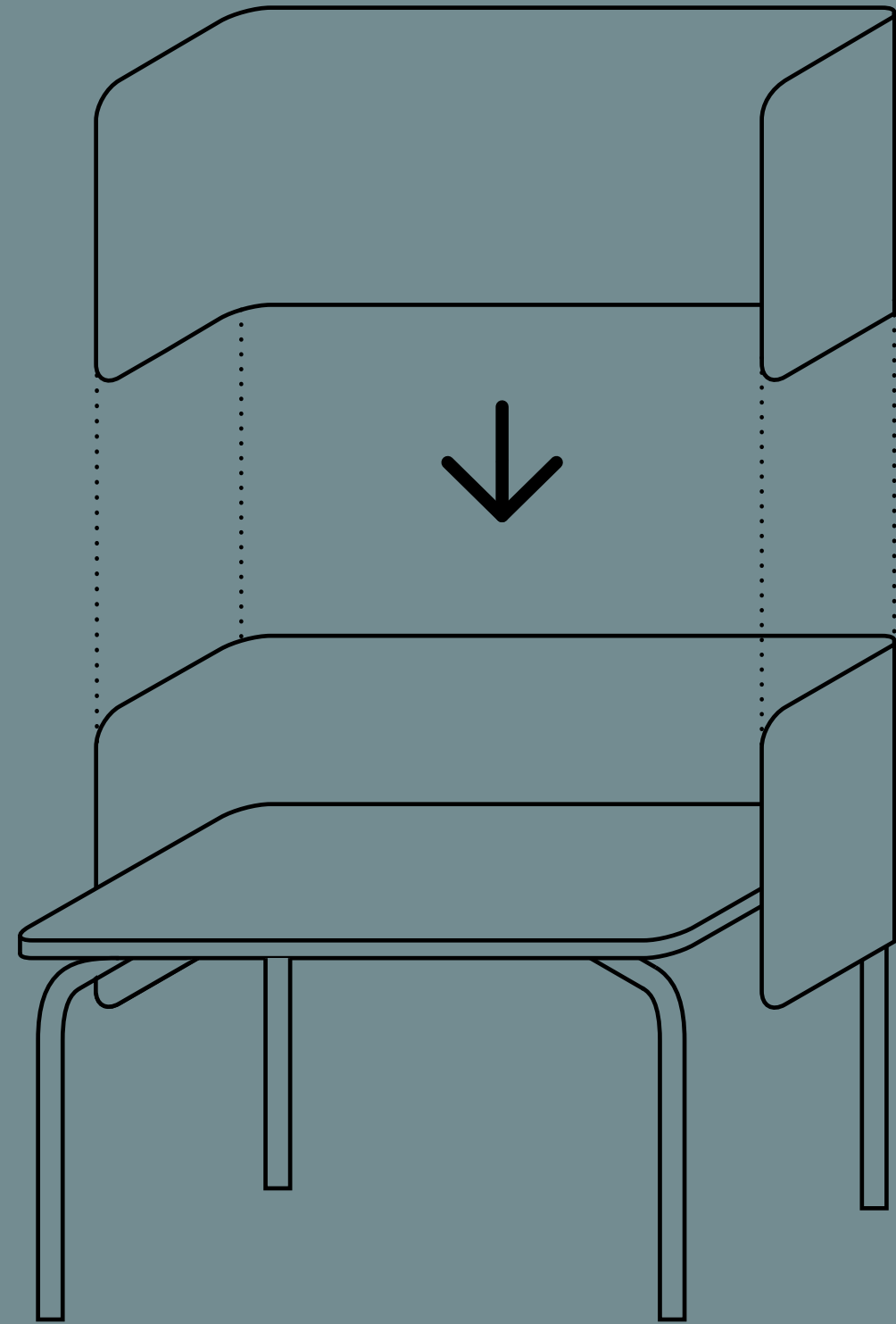

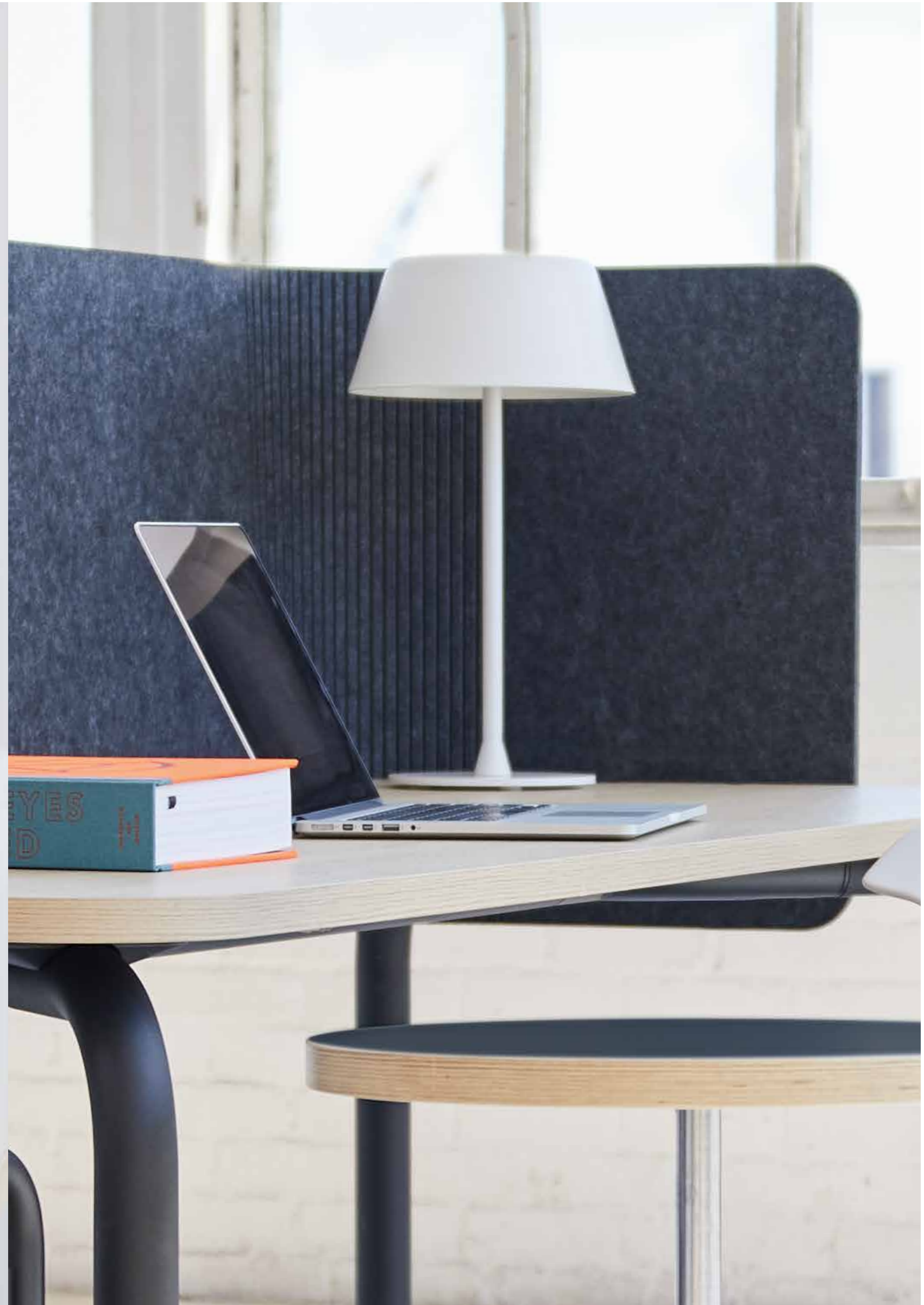

The Adjustable Side Table adds surface space for a laptop, notebook or coffee cup. The options are limitless—adjust the knob and find the perfect height to add dimension and functionality. This table coupled with any chair creates a new work point anywhere on a floor plan.

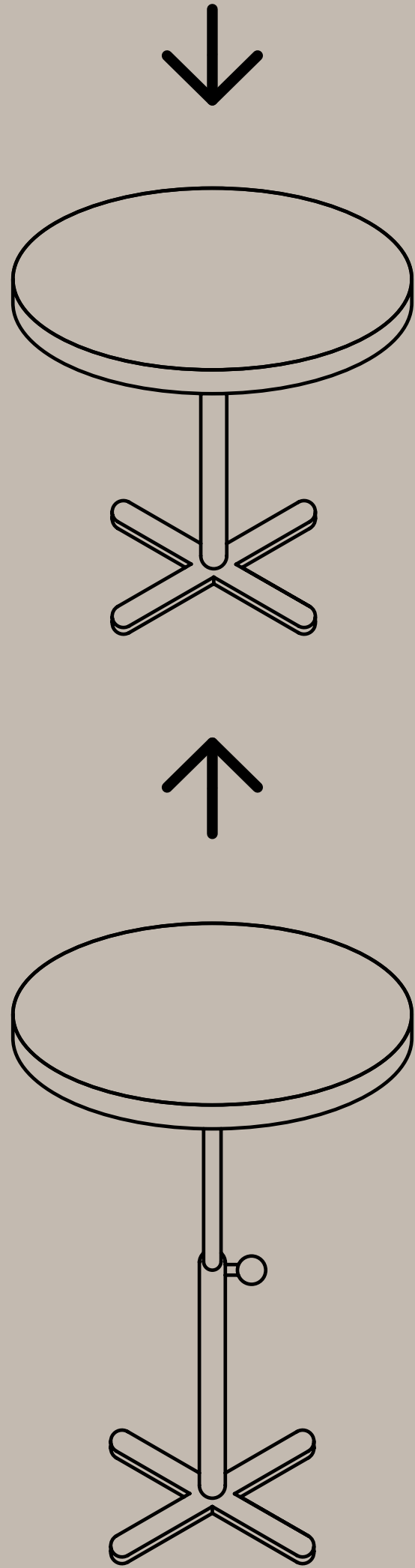

adjustable side table



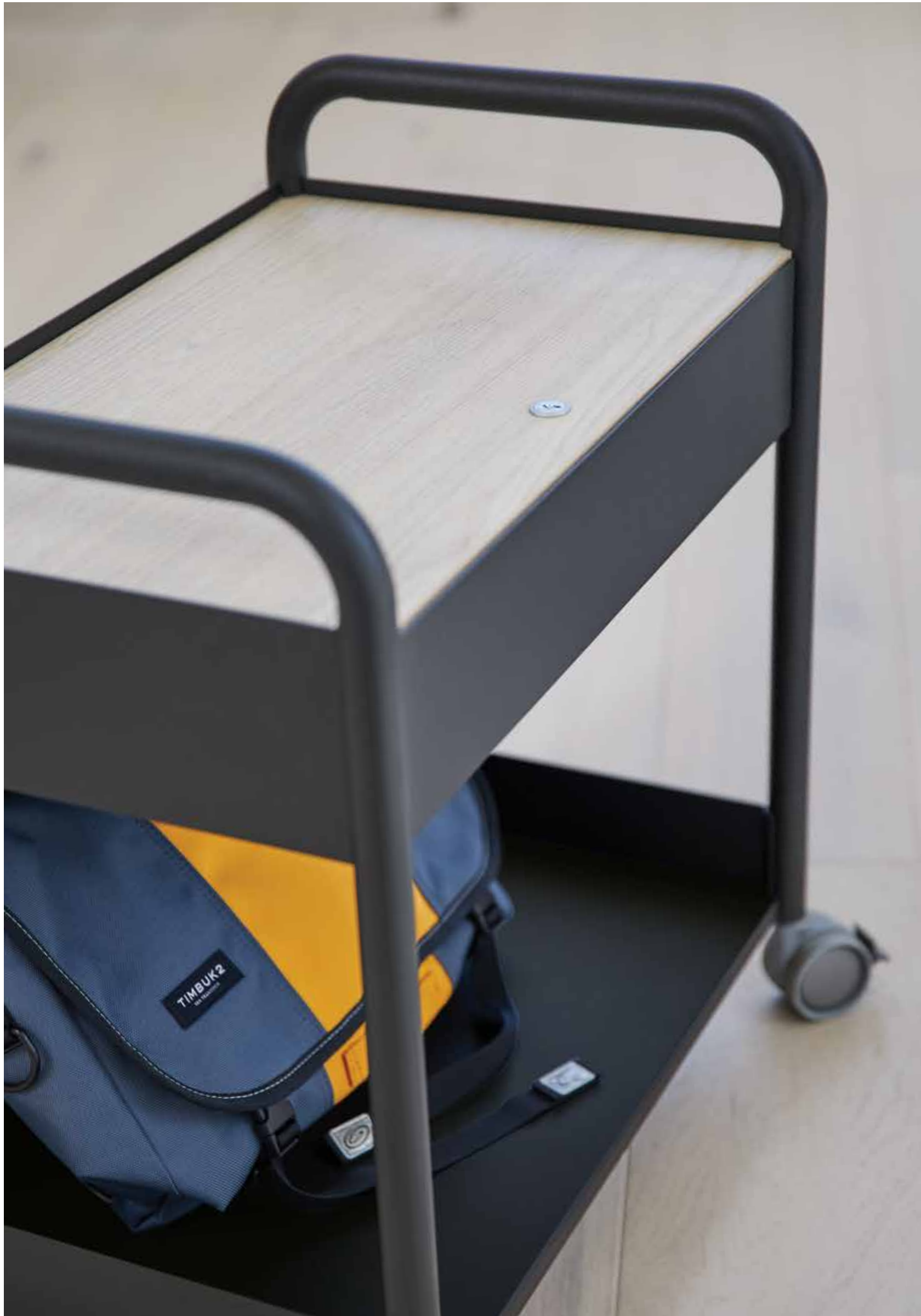

The way people work has changed and storage is evolving right along with it. With the Routes Personal Tote, not only is there space for personal items, a lockable drawer allows a secure spot for those special items.

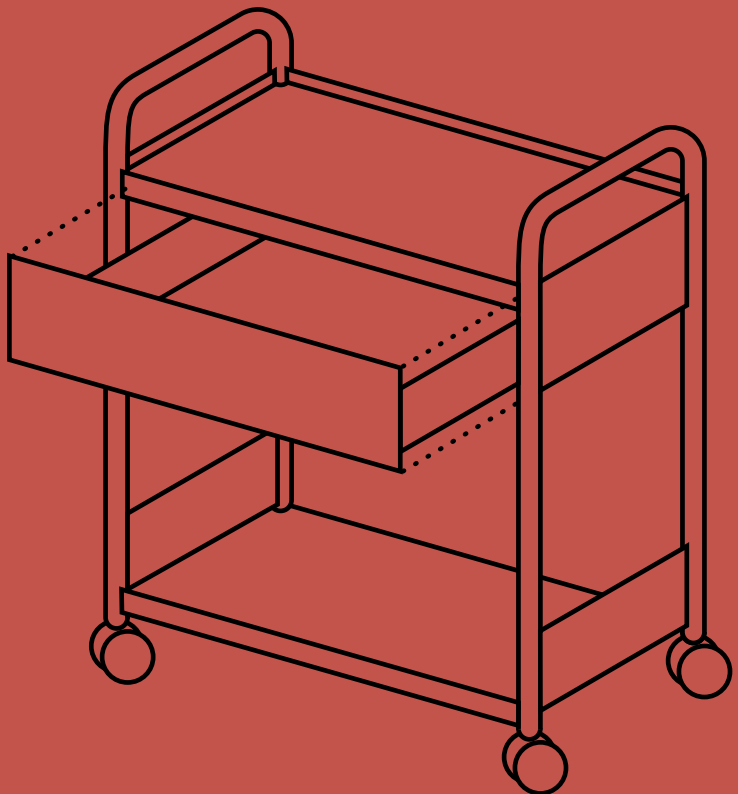

As well as facilitating collaboration, Routes empowers users to determine their optimum mode of work—standing, sitting, lounging, or whatever posture is most comfortable or appropriate to the task. Perch, cross-legged on the Arc chair with your laptop; wheel over the Mobile Soft Screen for an impromptu meeting; slide over the Multi-Use Stool for a chat with a colleague. With Routes, there's space for spontaneity.

com

m

fort





arc chair

The Arc chair delivers a lot of function, as well as comfort. It's more performance than lounge. A seat built for a bag, laptop and person—this chair provides a casual oasis in the corporate landscape.





Stack. Spin. Sit. The Multi-Use Stool is the utility seat that completes any creative space. A stack of stools enhances a room to change posture and mindset.

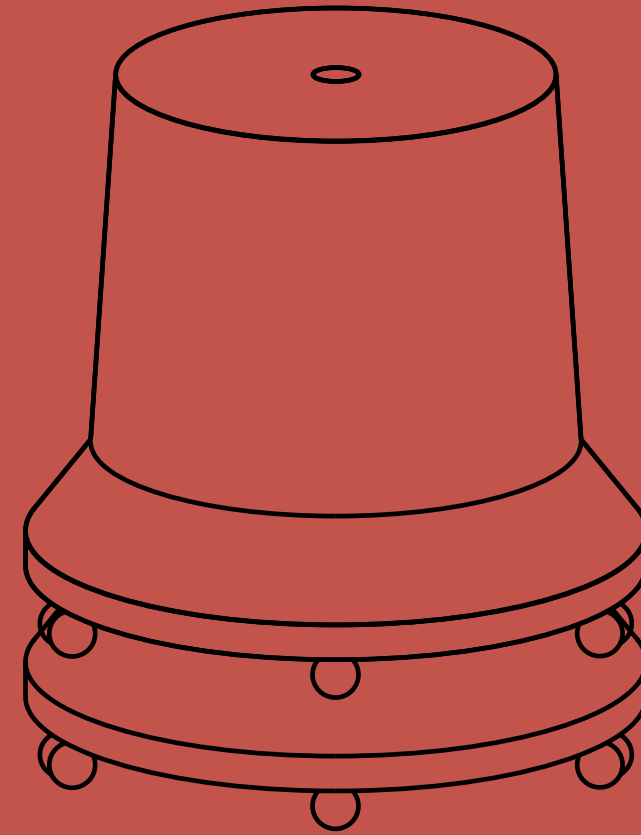
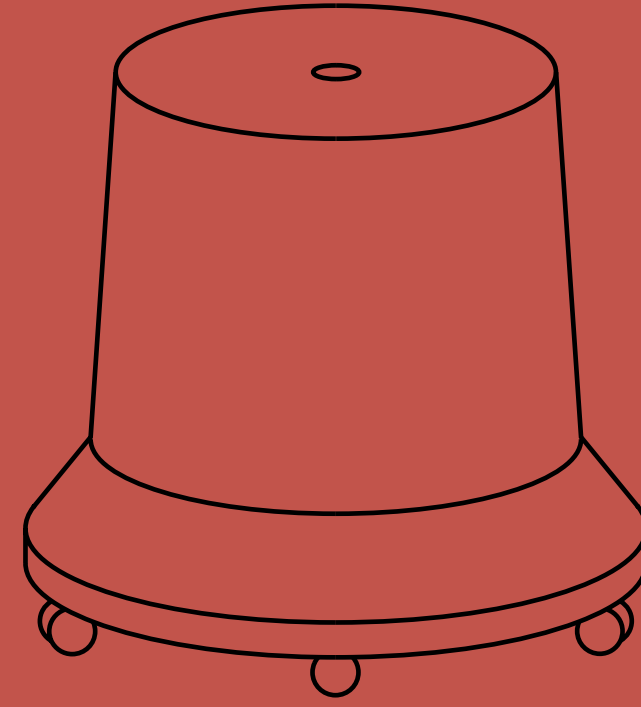



Comfort meets performance. The Meet n Greet chair, paired with the Routes Laptop Table, creates a dynamic space which users can settle into for the entire day.

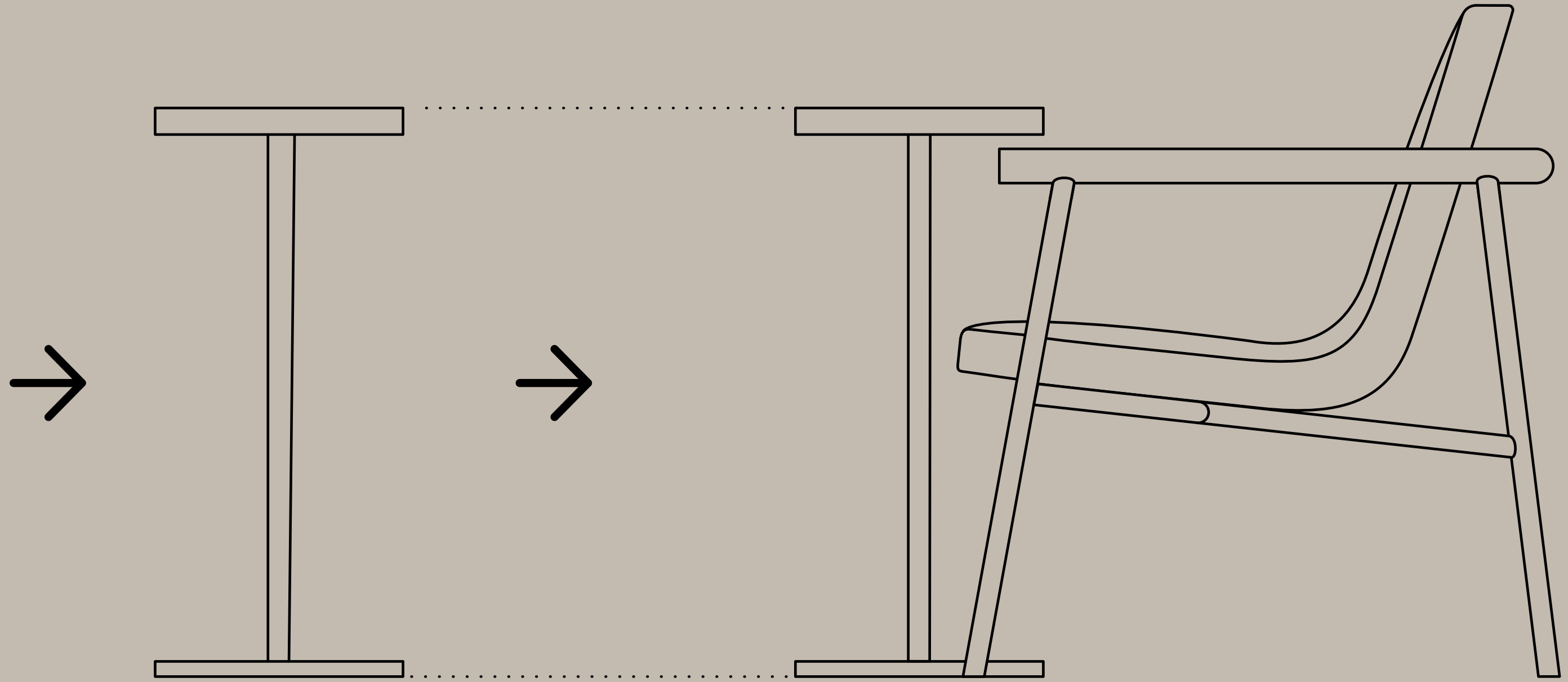

meet n greet chair / laptop table





Changing postures while working is empowering. Nothing changes posture quite like a rocking chair. The Routes Rocking chair brings a nostalgic casualness to the office environment.

rocking chair

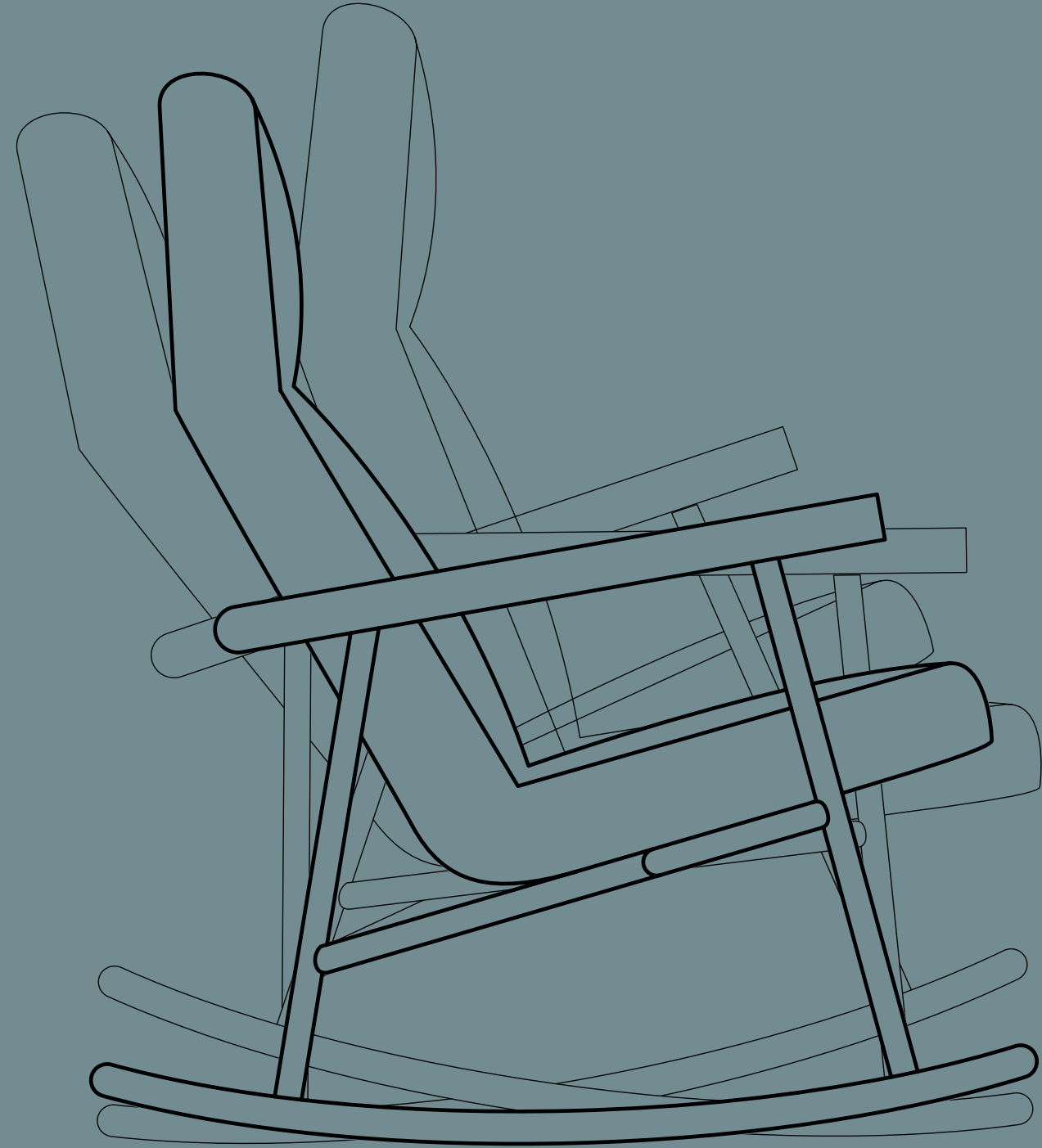

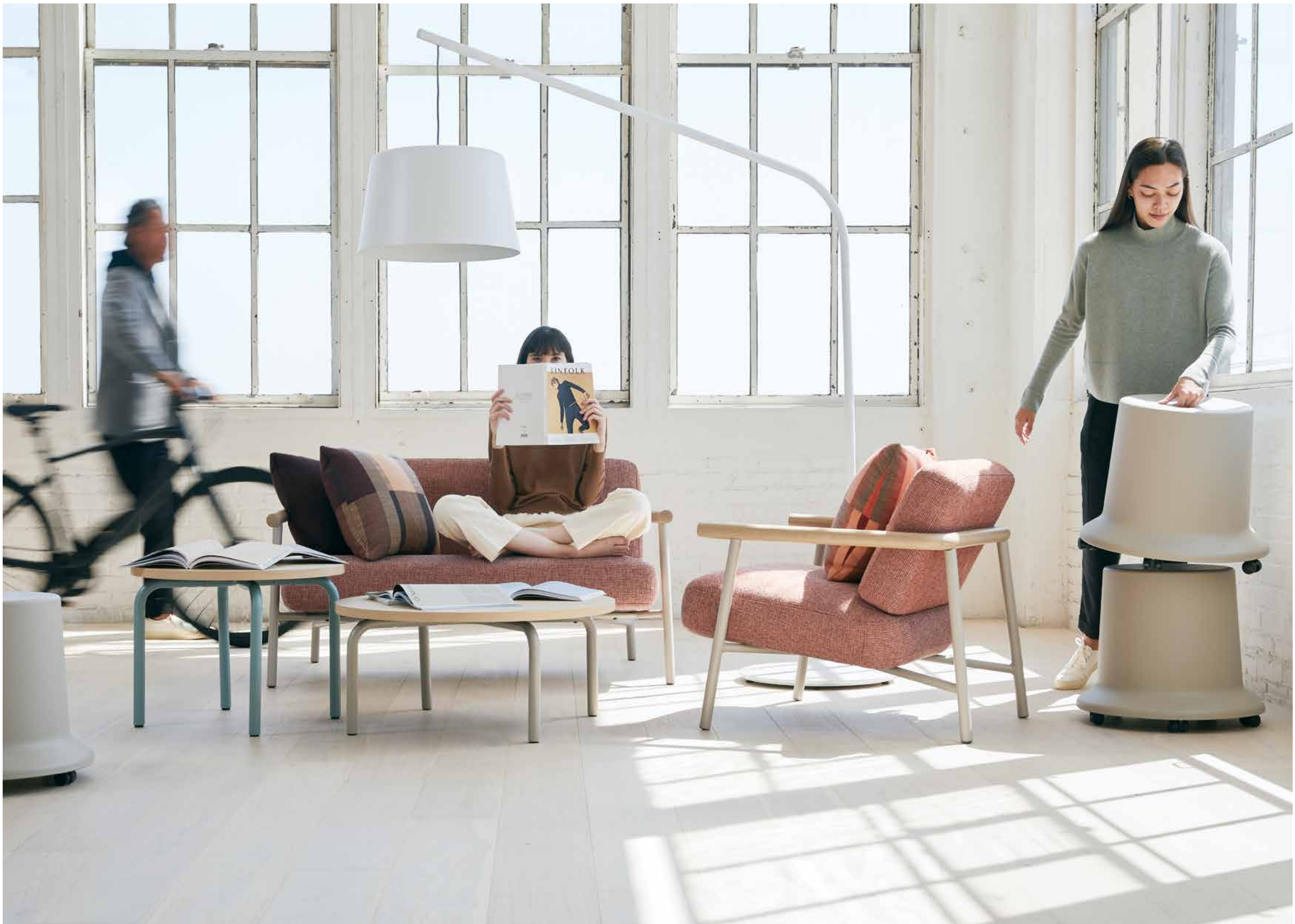

high table



"We wanted to avoid the cast aluminum, engineered aesthetic. In fact, the table has a utility character, almost cartoon-like, of something you might recognize from other spaces—which is very fresh. The big tubular

steel curve gives it quite a strong personality. It's a shape and a materiality that pops up across the collection and gives it a unity."
-Tom Lloyd

arc chair



"The Arc chair has quite a generous seat so that you can take your shoes off and get into the chair cross-legged if you like. At the same time, it shields the body in a very natural way. If you pull up a laptop table

or a side table, you've got a good working area. So, it delivers quite a lot of function, as well as comfort. It's more about performance than lounge."
-Tom Lloyd

mobile soft screen

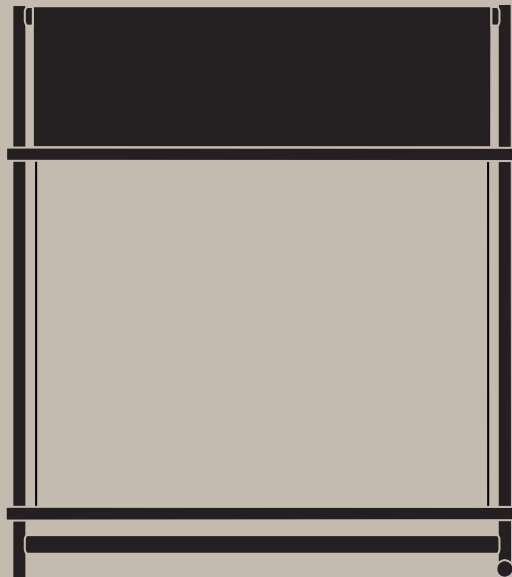

"Once again, the screen is almost like a found object, something you might use to get some privacy or problem-solve. It's very light, playful, friendly—almost like a towel rail or a drying rack. The Duo Chrome

double-sided textile simply drapes over, which allows you to play with color. It's very much about allowing people to make and manage a space."
-Tom Lloyd

three-leg stool



"When you use a four-legged stool, one leg always seems to be in the way. With the Three-Leg Stool it was intentional to promote side-to-side interaction and to allow you to step

off to the side without tripping on a leg. The stool is stackable as well, and it uses less material."
-Luke Pearson

adjustable side table

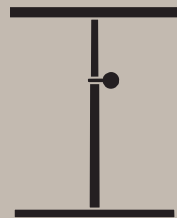

"As a student, I was inspired by the metal furniture of Jean Prouve; how you could just turn a screw to adjust it yourself. The Adjustable Side Table is rooted in that concept. The handle is intentionally

reminiscent of a bicycle seat adjustment. It's about utility. How simple can we be to get the function we want?"
-Luke Pearson

multi-use stool

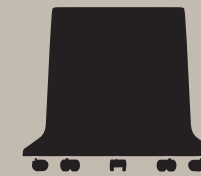

"My thinking came out of the ordinary experience of going to a hardware shop where you see a stack of 15 buckets in the corner. It's very efficient. So, let's take this idea and put wheels on it. We've all—maybe as students—grabbed

a box or turned a bucket upside down to sit on. The stool is just as efficient. And when you're not using it, stack it in a corner."
-Luke Pearson

soft seating

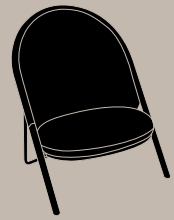

arc chair



rocking chair



meet n greet chair



lounge chair

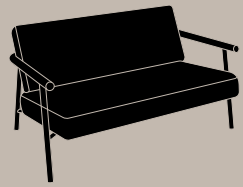

2-seater lounge chair



low back lounge

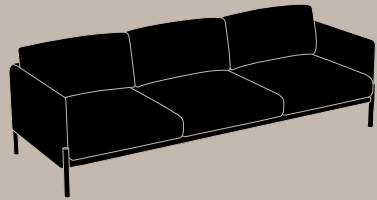

low back sofa, available in 2- and 3-seater

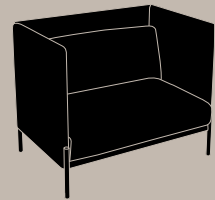

high back lounge

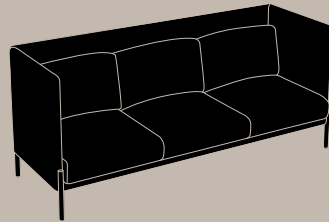

high back sofa, available in 2- and 3-seater

desks



double desk



single desk



smooth felt study carrel



knit mesh table screen

desk screens

tables



high table, bar height also available in counter height



round meeting table



square meeting table

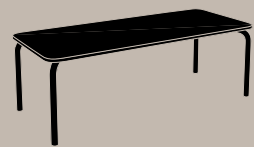

rectangular meeting table



oval coffee table



circular coffee table



rectangular coffee table



circular side table



square side table



adjustable side table



laptop table

multi-use seating



tube chair



tube stool counter height



tube stool bar height



takt cross chair



three-leg stool counter height



three-leg stool bar height



multi-use stool

storage and work tools



personal tote



shared tote



coat rack

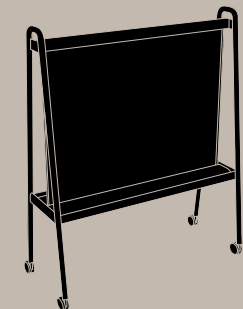

work board

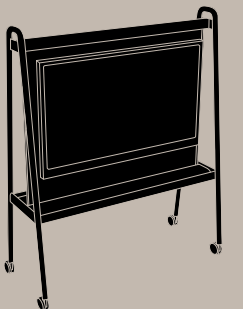

tech board

screens

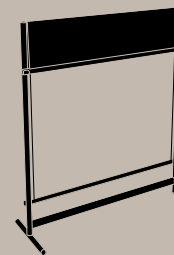

mobile soft screen

lighting



table lamp

routes relatives



essa task chair with adjustable arms also available armless and with fixed arms



sicla side chair also available with wood leg, rocker and five-star base



height-adjustable desk



floor lamp



arc lamp

no

ut

es

teknion

www.teknion.com

in canada
1150 Flint Road
Toronto, Ontario
M3J 2J5 Canada
Tel 866.teknion
866.835.6466

in the usa
350 Fellowship Road
Mt Laurel, New Jersey
08054 usa
Tel 877.teknion
877.835.6466

other offices located in
Europe, South and Central America,
Middle East, Asia and Russia
For regional contact information
go to www.teknion.com

can/us/int 06-21
© Teknion 2021
®, ™ trade marks of Teknion Corporation
and/or its subsidiaries or licensed to it.
Patents may be pending.

Brochure Design: Vanderbyl Design
Printed in Canada. BR-100-011EN

teknion